

# Harapófogó

530/4P



## Használat



## Profilok



[./hu/about-](#)

[us/materials\).](#)



[./hu/support/warranty\).](#)

## Termékjellemzők

- anyaga: Premium Plus szénacél
- kovácsolt, teljes anyagában nemesített
- vágóélek indukciósan edzettek
- fej kialakítása: finomkőszőrült
- felületkezelés: foszfátózott, ISO 9717 szabvány szerint
- mártott műanyag markolat
- ISO 9243 szabvány szerint

## Szabványok

DIN ISO 9243, A típus

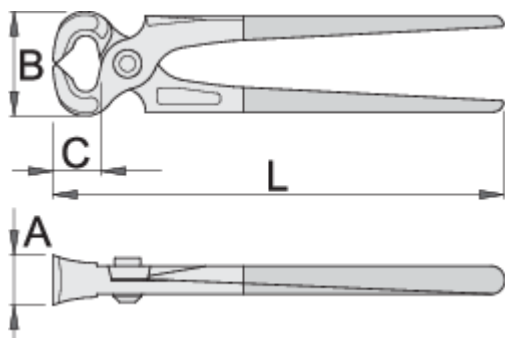

L

B

A

C



608722

160

46

22

16

242

608723



180

50

23



21

309

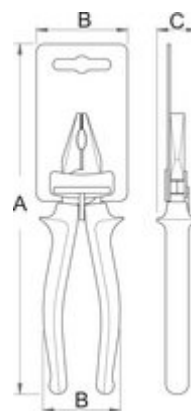
	L	B	A	C	
608724	200	54	25	24	427
608725	225	54	25	24	419
608726	250	58	26	27	557



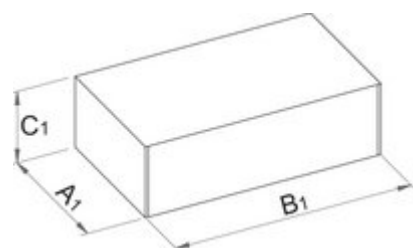

### Kiskereskedelmi csomagolás

	MA	MB	MC	
608722	235	72	37	255
608723	255	72	27	322
608724	270	72	27	440
608725	280	72	27	432
608726	310	72	27	570



### Szállítási csomagolás

		TA	TB	TC	
608722	4	134	268	53	1145
608723	4	145	358	48	1413
608724	4	109	377	65	1885
608725	4	145	358	48	1853
608726	4	145	358	48	2405