

Gépi dugókulcs, 1/2", 6 szögű

231/4 6p



Profilok



[./hu/about-us/materials](https://hu/about-us/materials)



[./hu/support/warranty](https://hu/support/warranty)

Termékjellemzők

- anyaga: Premium Flex króm-vanádium acél
- kovácsolt, teljes anyagában nemesített
- felületkezelés: foszfátzott, ISO 9717 szabvány szerint
- ISO 2725-2 szabvány szerint (metrikus méretek)

Szabványok

ISO 2725-2

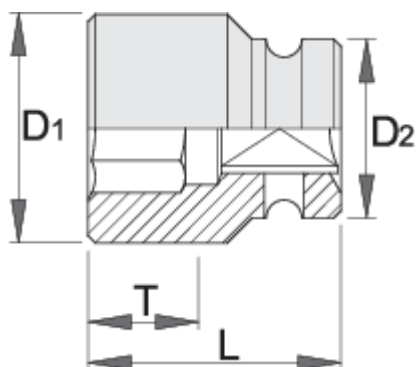



D1

D2

L

T



603962	10	17.5	25	38	12	94
603963	11	18.7	25	38	12	95
603964	12	20	25	38	12	95
603965	13	21	25	38	12	96
603966	14	22.5	25	38	12	95
603967	15	23.7	30	38	12	140
603968	16	25	30	38	12	143
603969	17	26	30	38	13	140
609399	18	27.5	30	38	13	135
603970	19	28.7	30	38	13	126
603971	21	30	30	38	13	139
603972	22	32	30	38	13	133
603973	23	32	30	38	13	183
603974	24	35	30	45	20	235
603975	27	38.7	30	50	24	235
609400	28	40	30	50	24	255
603976	30	42	30	50	24	259
605548	32	44	30	50	24	72
618710	3/8"	16	22	38	12	72
618715	11/16"	26	26	38	13	95
618717	13/16"	30	30	38	14	129
618720	1"	36	36	38	14	183

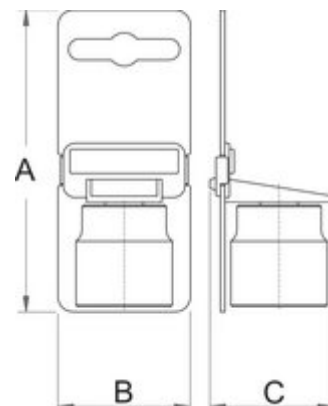

Kiskereskedelmi csomagolás





MA

MB

MC



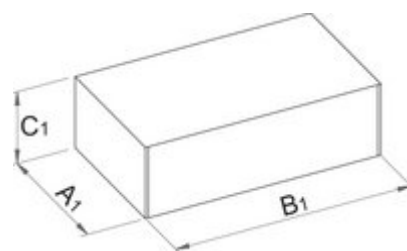

	MA	MB	MC	
603962	105	44	43	99
603963	105	44	43	100
603964	105	44	43	100
603965	105	44	43	101
603966	105	44	43	100
603967	105	44	44	145
603968	105	44	44	148
603969	105	44	44	145
609399	105	44	44	140
603970	105	44	44	131
603971	105	44	44	144
603972	105	44	45	138
603973	105	44	45	188
603974	105	44	46,5	240
603975	105	44	48,35	240
609400	105	44	49	260
603976	105	44	50	264
605548	105	44	51	77
618709	105	44	43	77
618710	105	44	43	77
618711	105	44	43	77
618712	105	44	43	74
618713	105	44	43	88
618714	105	44	43	94
618715	105	44	43	100
618716	105	44	43	113
618717	105	44	44	134
618718	105	44	45	150
618719	105	44	46	170
618720	105	44	47	188

Barcode	MA	MB	MC	Weight
618721	105	44	48	220
618722	105	44	49	231
618723	105	44	50	246
618724	105	44	51	253
618725	175	80	45	276
618726	175	80	48,5	333
618727	175	80	50,5	374
618728	175	80	52,5	376



Szállítási csomagolás

Barcode	Hand icon	TA	TB	TC	Weight
603962	4	93	144	57	521
603963	4	93	144	57	525
603964	4	93	144	57	525
603965	4	93	144	57	529
603966	4	93	144	57	525
603967	4	93	144	57	705
603968	4	93	144	57	717
603969	4	93	144	57	705
609399	4	93	144	57	685
603970	4	93	144	57	649
603971	4	93	144	57	701
603972	4	93	144	57	677
603973	4	93	144	57	877
603974	4	93	144	57	1085
603975	4	93	144	57	1085
609400	4	93	144	57	1165
603976	4	93	144	57	1181

		TA	TB	TC	
605548	4	93	144	57	433
618709	4	93	144	57	433
618710	4	93	144	57	433
618711	4	93	144	57	433
618712	4	93	144	57	421
618713	4	93	144	57	477
618714	4	93	144	57	501
618715	4	93	144	57	525
618716	4	93	144	57	577
618717	4	93	144	57	661
618718	4	93	144	57	725
618719	4	93	144	57	805
618720	4	93	144	57	877
618721	4	93	144	57	1005
618722	4	93	144	57	1049
618723	4	93	144	57	1109
618724	4	93	144	57	1137
618725	1				
618726	1				
618727	1				
618728	1				